

- NOTE:**
- * Three tier bouquet merchandising set
 - * Features or options not illustrated will be itemized on written proposal and specified on purchase order.
 - * T8 High output lighting
 - * McCue 1" bumper
 - * Expansion valve: Sporlan "F" Series standard unless specified otherwise.
 - * Defrost control: N/A Remote systems (Digital case controllers optional) Optional Top mount condensing unit (Digital case controller)
 - * T'stat & liquid line solenoid valve installed
 - * Drain: 1-1/2" drain pipe
 - * Specifications subject to change without notice

CASE SPECIFICATIONS:

REFRIGERATION:
 LOAD: 1250BTU/FT/HR
 DISCHARGE AIR: 35o
 EVAPORATOR: 28o
 UNIT SIZING: 26o

DEFROST DATA:
 FREQUENCY HOURS: 8
 OFF TIME MINUTE: 20

LIQUID LINE: 3/8"
SUCTION LINE: 7/8"
DRAIN PIPE: 1-1/2"

ELECTRICAL REQUIREMENTS					
MODEL	FANS	TOTAL	COMPRESSOR	PAN*	
	115V	115	HP	208/230	115V
5436CHT	1.3	1.3	3/4	7.0	12.5
7236CHT	1.7	1.7	3/4	7.0	12.5
7936CHT	2.6	2.6	3/4	7.0	12.5
9636CHT	3.4	3.4	N/A	N/A	N/A

*Requires separate circuit for optimum operation



PROJECT NO.		LaGRANGE PARK, IL. 60526	
DWN S. BERRY		P.O. BOX 1322	
DATE	CHK	TITLE	
		OPEN LO-PROFILE	
UNLESS OTHERWISE SPECIFIED DIMENSIONS ARE IN INCHES TOLERANCES		SIZE	DWG NO.
ANGLES ±5° FRACTIONS ±1/16		A	P36 CHT
DO NOT SCALE		SCALE NTS	REL DATE 05/20/06 SHEET 0F

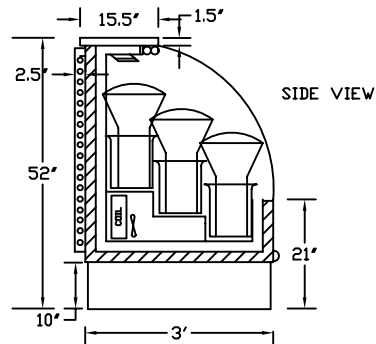
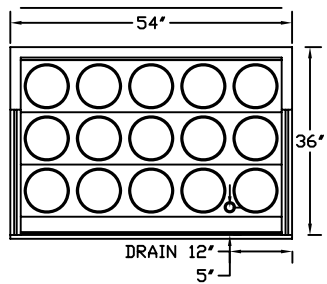

NOTE:

- * Three tier bouquet merchandising set
- * Features or options not illustrated will be itemized on written proposal and specified on purchase order.
- * T8 High output lighting
- * McCue 1" bumper
- * Expansion valve: Sporlan "F" Series standard unless specified otherwise.
- * Defrost control: N/A Remote systems (Digital case controllers optional) Optional Top mount condensing unit (Digital case controller)
- * Thermostat & liquid line solenoid valve installed
- * Drain: 1-1/2" drain pipe
- * Specifications subject to change without notice

CASE SPECIFICATIONS:

REFRIGERATION:
 LOAD: 1250BTU/FT/HR
 DISCHARGE AIR: 35°
 EVAPORATOR: 28°
 UNIT SIZING: 26°

DEFROST DATA:
 FREQUENCY HOURS: 8
 OFF TIME MINUTE: 20

LIQUID LINE: 3/8"
 SUCTION LINE: 7/8"
 DRAIN PIPE: 1-1/2"

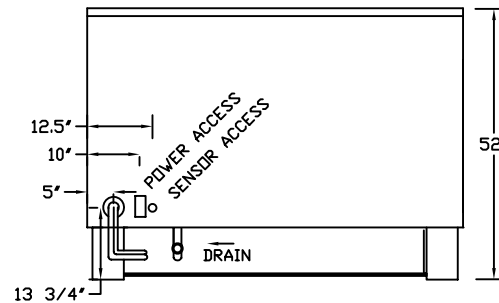
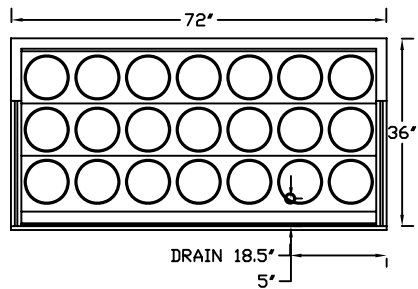

MODEL	ELECTRICAL REQUIREMENTS					
	LIGHTS 115V	FANS 115V	TOTAL 115	COMPRESSOR		PAN*
				HP	208/230	115V
5436CHO	0.49	1.3	1.79	3/4	7.0	12.5
7236CHO	0.66	1.7	2.37	3/4	7.0	12.5
7936CHO	0.66	2.6	3.26	3/4	7.0	12.5
9636CHO	0.98	3.4	4.38	N/A	N/A	N/A

*Requires separate circuit for optimum operation

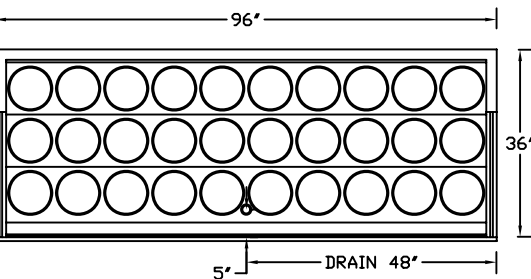
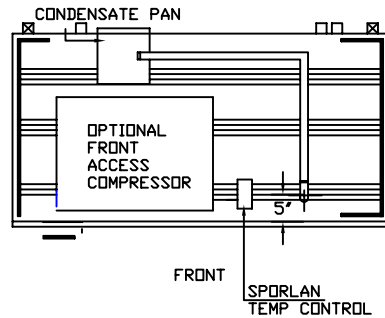
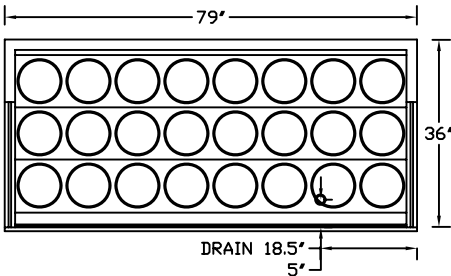

PROJECT NO.		DATE		M E I LaGRANGE PARK, IL. 60526 P.O. BOX 1322	
DWN S. BERRY		CHK		TITLE OPEN LO-PROFILE WITH CANOPY & LIGHT	
UNLESS OTHERWISE SPECIFIED DIMENSIONS ARE IN INCHES TOLERANCES		SIZE A		DWG NO. P36 CHO	
ANGLES ±5° FRACTIONS ±1/16 DO NOT SCALE		SCALE NTS		REL DATE 05/20/06 SHEET OF	